



**BRITISH MODEL FLYING ASSOCIATION
THE R/C ACHIEVEMENT SCHEME**

**TEST STANDARDS for CHIEF EXAMINERS
and CLUB EXAMINERS
GUIDANCE for TEST CANDIDATES**

**THE HELICOPTER CERTIFICATES
(Basic Proficiency, A & B)**

2017 ISSUE

General

The Achievement Scheme is run by the BMFA as a National Scheme and it is open to all model flyers. Where a non-member wishes to participate in the achievement scheme the examiner who will be conducting the test must inform the BMFA office via email or telephone no later than the day prior to the test being carried out of the non-member's full name, address and the date that the test will be conducted. This enables the BMFA to extend insurance at suitable levels for the day of the test. If this procedure is not followed the test will be invalid.

The examination for a 'BPC' or A Certificate may be taken on application to any Registered Examiner.

The examination for a 'B' certificate may be carried out by:

- (a) Two Registered Examiners (the 'lead' must be a Helicopter Examiner).
- (b) A Helicopter Chief Examiner

The candidate must successfully complete the test schedules in one attempt. A maximum of two attempts at the examination are permitted in any one day.

The test schedule is split broadly into five areas; the pre-flight safety checks, moving from the pits/start-up area to the take-off/landing area, the flying manoeuvres, the recovery & return to the pits, and the questions.

Basic Proficiency Certificate (BPC) & 'A' Certificate

The 'BPC' is a measure of flying ability and safety which "may be equated to a safe solo standard of flying" for aircraft that do not meet the requirements for the A certificate.

The 'A' Certificate is a measure of flying ability and safety which "may be equated to a safe solo standard of flying" and an increasing number of clubs use it as their 'solo' test.

The test for the BPC is exactly the same as that conducted for the 'A' test.

As an Examiner, the level of competence you should expect of a candidate should be based on that criterion; that is 'is this person, in your opinion, fit to be allowed to fly unsupervised'.

The candidate should have studied the BMFA handbook, CAP 658, any local site rules (if applicable) and be familiar with the 'Safety Code for General Flying' and the 'Operational Guide, All Models and Radio Control'. Besides being an excellent guide to the safe flying of model aircraft, most of the questions asked at the end of the test will be from these sections of the handbook and CAP 658.

There is a section in the Handbook that gives the relevant page numbers of these sections but remember that addendum sheets to the Handbook are published in BMFA News and on the BMFA website and these may also be relevant as they contain up-to-date information.

Also be aware that you may ask questions on any local site rules that the candidate should be aware of and these may form an important part of the test questions you ask.

The 'B' Certificate

The 'B' Certificate is “designed to recognise the pilot's more advanced ability and a demonstrated level of safety which may be considered by an event organiser as suitable for flying at a public display.”

As an Examiner, therefore, the level of competence required from a candidate should firstly be based on the question; 'has this person demonstrated their flying ability and safety to me in a satisfactory manner' and, secondly, 'how do I feel about them appearing in public, possibly at a large display, on the strength of the certificate which I may be about to award them'.

The aim of the 'B' certificate has always been to give the club flyer a personal attainment goal beyond the 'A' Certificate; a demonstrated level of competence and safety which is attainable by the average pilot with a little thought and practice.

For many years the 'B' Certificate has been seen by some as a 'display licence' but, whilst it certainly has its uses in the context of displays, it has always been much more than that. It was set up in the first place as a method of encouraging club flyers to gain further flying skills by meeting and being tested to a recognised national standard and this is still its main function.

The long term strategy behind this is that if enough club flyers qualify for their 'B' certificates then the general standard of flying both within your club and nationally cannot help but rise. Examiners should be pressing this concept positively within their clubs and discouraging the idea of the 'B' as 'just a display licence'.

A candidate wishing to take the 'B' must already have passed the 'A' in that discipline.

However where a candidate presents for a B test who does not already hold an 'A' certificate it is acceptable for the candidate to complete the flying portion of the 'A' test successfully and then move immediately to the flying portion of the 'B' test before attempting the test questions.

If the candidate passes the 'A' flying test but fails the 'B', then you should ask the 'A' questions. If the candidate passes both the 'A' and the 'B' flying tests, then you should ask the 'B' questions.

Note that the 'A' flying test does not finish until the model has been retrieved and the post flight checks have been completed

The candidate for the 'B' should have studied the BMFA handbook and CAP 658 and be familiar with the 'Safety Code for General Flying', any local site rules (if applicable), the 'Operational Guide, All Models and Radio Control' and the 'Safety Code for Model Flying Displays'. Most of the questions asked at the end of the test will be from these sections of the handbook and CAP658.

Outdoors

The test may not be flown indoors. It was designed to be flown outdoors and the text of the test manoeuvres highlights this. It is important to remind candidates that their ability to cope with various wind conditions is an integral part of the test.

The Model

The test can be performed with virtually any model helicopter, fixed pitch or collective. The helicopter may be internal combustion engine powered or electric powered. The only exception to this is that helicopters with contra-rotating main rotors are not permitted for the 'A' and 'B' tests, the reasoning being that is these models are generally too stable to provide an adequate test of a candidate's abilities.

Whether the candidate takes a **BPC** or an 'A' cert depends entirely on what model they present with for the test;

- If they present with a contra-rotating helicopter, they will take a **BPC**
- If they present with a flybarless helicopter where the electronics are only acting as a fly bar replacement system they will take the 'A'
- If they present with a flybarless helicopter where extra electronic stabilisation is active (such as self levelling) they will take the 'BPC'
- If they present with a helicopter with a flybar and only a tail gyro they will take the 'A'

Whatever model is brought by the candidate, it must be suitable to fly the manoeuvres required by the test they are taking. You do not have the authority to alter the required manoeuvres to suit a model and if, in your opinion, the model is unsuitable for the test then you should explain this to the candidate and tell them that they cannot use that model. The selection of the model to do the test is the responsibility of the pilot and it is their ability you are testing, not the model.

On no account may the candidate use defects or limitations in the performance of the model as an excuse for poor performance on their part and you should make no allowance on this point. The type of model presented cannot be used as an excuse for not completing certain manoeuvres.

Electric Powered Models must be treated as LIVE as soon as the main flight battery is connected, irrespective of radio state and great care must be demonstrated by the candidate. The arming sequence should be clearly understood and discussed/demonstrated to you by the candidate.

Buddy Box Systems

Buddy leads and other dual control training aids must not be used during any achievement scheme test.

Gyros, Electronic Stabilisation and GPS

Where a fly bar is fitted, it is acceptable to use an electro-mechanical or solid state gyro in a helicopter being used to take the test although electronic stabilisation is restricted to a single sensor acting in rotation around the yaw axis only. This allows a range of gyros to be fitted, from simple yaw dampers to solid state heading lock units but only acting on the tail rotor.

If the helicopter does not have a fly bar fitted it is acceptable to use extra electronic stabilisation, however the extra electronic stabilisation must only be acting as a fly bar replacement system and must not take over control from the pilot or achieve automated flight.

The use of any autopilot and/or artificial stability features which are (or may be) designed into such units beyond definition above is not acceptable during the test for the 'A' and 'B' certificates and is not permitted, **however for the 'BPC' only it is acceptable to have self levelling activated.**

Candidates should be prepared to explain the capabilities of the system they are using and show that it does not take over control from the pilot and that automated flight will not be achieved during the test.

GPS must not be used during any test.

Height and Speed

The 'BPC' & 'A' certificate candidate should be a reasonably confident pilot, even though they may have been flying helicopters for only a few months. Flying too high or too low is not the mark of a confident pilot. The test should be flown at the heights specified in the individual elements with little deviation.

The two manoeuvres in the 'A' certificate test require slightly different speeds as will be explained on the manoeuvre descriptions.

The 'B' certificate candidate should be a confident pilot, and this should show in the height and speed at which they fly the test. The hovering parts of the test should be flown with the model at 10 feet. The flying sections should typically be completed at a height of between ten and twenty five meters (roughly one to two houses high). The pilot should show good use of the controls to maintain a constant height throughout each of the separate elements of the test and transitions between various heights should be smooth and steady. Height selection and accurate height control are factors you should attach some importance to.

Wind Direction

There is no requirement for the fixed positioning of manoeuvres relative to the wind direction in the Helicopter tests and you will find no reference to the wind in the text of either the test or this Standards Document.

This makes it absolutely ESSENTIAL that you discuss this with the candidate at length so that you are both aware of exactly how you want the manoeuvres to be presented and what limitations will be accepted if the wind direction is not favourable.

Consistency

Good use of the controls should ensure that the model stays at a constant height, and moves at a steady speeds suitable to each of the separate elements of the test. All deviations from these constants should be noted, and will form part of the judgment of the test.

Unnecessary varying of height and inconsistent lines are valid reasons to fail a candidate at this level as they give a good indication of the flyer's general level of competence and they must strongly influence your final decision. Poorly flown height or lines are a sure sign that the flyer has either not practiced the test or has not reached the required standard of flying and are legitimate reasons to fail them.

Continuity

For the 'BPC' and 'A' test the manoeuvres are set out in such a way that they are flown one after the other as a short sequence. You should discuss with the candidate before the flight the way in which you would like the various elements flown and the candidate should have a good knowledge of the test before the event. If the candidate is very hesitant during the test and is not capable of following the set sequence then you might conclude that they have either not had enough practice or that their basic flying skills are not yet well enough developed.

For the 'B' test, although the manoeuvres are set out as a sequence, it is **ABSOLUTELY NOT** expected that they will be flown as a schedule with one manoeuvre flowing into the next. The candidate may opt to fly the test in that manner but that is their choice. Most flights will have a combination of transitions and positioning circuits between the various elements and you should note any additional flying for positioning etc., just as carefully as the rest of the flight, as this can say much about the competence of the pilot.

A pilot who transitions directly from one manoeuvre to the next is not to be penalised as this is quite acceptable, but watch out for the pilot who is not sufficiently practiced. Flying some of the manoeuvres in this manner can get them into some very awkward positions. The candidate should have a good knowledge of the test before the event.

It should be possible to fly the test on one tank of fuel or flight battery but if the model does have to be refuelled or the flight battery changed then the pilot must clear this with you before the test starts as required by the test procedure. It is allowable only once during the test and anything the pilot does during this time must be considered by you to be part of the test. This includes the way they land, retrieve, carry out and take off. With I/C models the correct refuelling and start procedures must be used, For electric models, isolating the flight battery before carrying the model in and not re-connecting until the model has been carried out to an appropriate safe point are important.

Trim

It is expected that the candidate will start the test with a model that has been trimmed out previously but, if necessary, they should be able to trim the model out relatively quickly. If you see obvious signs that the model is out of trim and the candidate makes no attempt to rectify the matter, you may well question their basic competence. On the other hand, if they do need to re-trim and are making attempts to do so, you should make allowances for a short time of flight with a somewhat erratic path. This should not be penalised unless it puts the model in any dangerous situations or unless the model flies behind the pilot or into any other unsafe area. If the pilot does use the first part of the flight as a trimming exercise, they should be required to land as soon as they are satisfied with the trim and the test should then commence at manoeuvre (b). If a flight is abandoned prior to starting manoeuvre (b) because of trim problems it will not count as a test flight attempt.

Nerves

Quiet competence is what you are looking for during the flight, but most candidates may well be nervous and you should make some allowance for this. If the flyer is very nervous you should seriously consider abandoning the test for the time being and arranging a coaching flight or two to settle the candidate down before re-taking the test. This can be done on the same day and can really help those candidates who have trouble with nerves when flying in a test situation.

Repeating Manoeuvres

At 'BPC' and 'A' certificate level the manoeuvres are simple and the candidate should be competent to fly them with very few errors. At 'B' certificate level the candidate should be competent to fly the more advanced manoeuvres in the test with very few errors. If you see any major faults the test should be taken again. It may be, however, that the candidate will make a **minor** mistake on a manoeuvre and if you are not fully satisfied with what you have seen you should consider asking for the manoeuvre to be repeated.

Some judgement is called for on your part here. A major mistake is grounds for failing the candidate, especially if loss of control has occurred or a dangerous situation has arisen. You should definitely not let them have multiple attempts at each manoeuvre until they get it right but you must give yourself the best chance of assessing the competence of the pilot you are testing.

You should consider what you have seen the model do and if you think to yourself "could be better" then a request that the manoeuvre be repeated may be considered. Be extremely careful about using this option, however, as you could very easily be degrading the worth of the test. It must not, under any circumstances, degenerate into a series of 'practice' manoeuvres.

Repeating the test

The rules allow two attempts at the test in one day and if the candidate fails the first of these you must consider their performance in deciding what to do next. Many failures will be reasonably good or borderline cases and in these circumstances it may be appropriate to arrange one or two coaching flights before repeating the test. Remember that many of the candidates will be unfamiliar with flying under pressure and might do very well on the second test.

However, it will probably be obvious to you on many occasions that the pilot you are testing is simply not ready for the test they are taking. In this situation it is better that you tell them so quite clearly. It could then be extremely useful for you to arrange a demonstration test for them so that they can gain an understanding of the standard of flying that is required, especially if they are not clear about the manoeuvres and the positioning for them. This, possibly with a little coaching, is far more useful to everyone than simply telling the candidate that they have failed.

A flight which is abandoned for any reason prior to starting manoeuvre (b) will not count as a test flight attempt

Interruptions to the Test

A possibility that may occur during a test is a motor failure part way through, which with helicopters could very well lead to a damaged model. If this is the case then the test obviously cannot continue and you should invoke the rule that the test should be performed in one flight and count the flight as one of the two attempts allowed during the day.

Genuine motor/engine trouble or even motor/engine-out situations during the test may be dealt with in one of three ways.

If the test was being generally flown in a satisfactory manner and the problem can be rectified quickly then the candidate may be allowed to continue the test from the start of the manoeuvre in which the problem occurred.

If the problem cannot be rectified quickly but you consider that it was a genuine unforeseen occurrence, you may annul the test and not count it as one of the two attempts.

If the test up to the point of failure was not satisfactory, you have the option to cancel the rest of the test and count the flight as one of the two attempts allowed during the day.

Obviously, you will have to use your judgment on this matter as there will rarely be black and white situations but how they handled the emergency should be of great interest to you when you come to review the candidate's overall standard of flying.

Ground Positioning

When taking a helicopter test, it is your responsibility as the Examiner to lay out a series of ground markers to assist both the candidate and yourself to assess the manoeuvres being flown. Small cones or any other similar marker may be used as long as they don't interfere with the flying of the model. However, it is vital that the marker used for the take off/landing point (TOLP) does not affect the model at all and probably the best marker in this case would be something like the fluorescent discs that lay flat on the ground. Alternatively, you could use some of the biodegradable ground marker spray paint that is readily available.

The layout of markers required is shown below and it must be emphasised that absolute accuracy of distance is not required when setting them out. Pacing will be quite accurate enough. It is essential, though, that the centre marker, the TOLP and the pilot's position are in line.

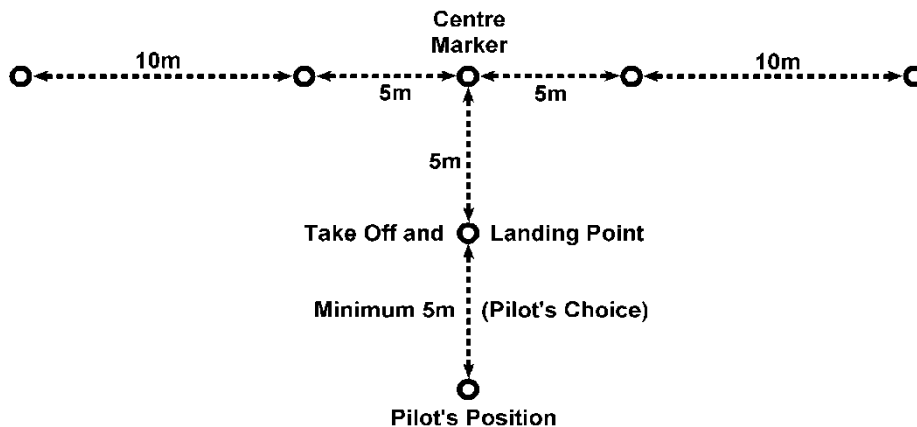

GROUND POSITIONING MARKERS

The general positioning of the markers will depend very much on the geography of the flying site and safe operation of the model and you should set them out with these factors in mind.

It is not a requirement that the markers in the cross bar are used by the pilot but they are there to help. However, the centre marker, the takeoff/landing point and the pilot's position must be used with some accuracy.

Landings should generally be no more than a metre from the takeoff/landing point and the pilot is expected to stay close to the selected pilot's position mark although it is not required that they 'plant' their feet. If you feel that the pilot is starting to wander, you should stop them and insist that they stand near the pre-selected mark.

Remember that it is a requirement that 'all manoeuvres are carried out in front of the pilot' so the use of the pilot's position point will be important.

General Manoeuvres and Hovering

All take-offs and landings should be smooth, without undue oscillations, and lifts and descents should be straight and controlled with the model a comfortable and safe distance in front of the pilot. In any stationary hovering the model should remain steady and should not oscillate unduly.

The standard 'brief' hover time is about five seconds. You should discuss this with the candidate before the test so that they know that you will want to see a positive stop with the hover long enough to show that the model is well controlled and steady with little wandering or oscillation. Stopwatch accuracy is not required.

The candidate should also be aware that the decision to move on is theirs and that you will not be asking them to commence with the next manoeuvre. However, during your pre-flight briefing, they may ask that you indicate when you are satisfied that they have completed their 'brief' hover times to help them decide when to move on. This is quite permissible if requested by the candidate.

Circuit and other 'flying' manoeuvres should be performed at the heights mentioned in 'Height and Speed' above. Movement of the model from one point to another whilst in the hover should be done at a steady walking pace.

Care should be taken in the flying manoeuvres that the line of approach and height each time is consistent and you should take particular note of performance in this area.

Intermediate Landing

Exceptionally, at a pre-determined point in the flight an intermediate landing may be permitted for the sole purpose of the fitting of a freshly charged flight battery. This landing may only be made with the prior consent of the Examiners. The pre-determined point may be either after a specific manoeuvre or at a specific time of flight, whichever is requested by the candidate and agreed by the Examiners.

Full pre and post flight checks are not normally required during an intermediate landing and takeoff unless the model suffered a hard landing. However, the candidate should give the model at least a quick visual examination whilst on the ground.

Helpers for Disabled Candidates, Young Candidates and Others Who have Requested Help During the Test

When disabled or young candidates present themselves for the test it may be that they will not physically be able to perform all the actions that most candidates can. At times, other candidates may also request help with certain physical aspects during the test (they may, for instance, have an injured finger). There will be times when you, as an Examiner, will think 'how much can I relax the test requirements for this person'.

Some Examiners make the decision to make no allowances at all but this effectively bars many people from attempting the tests. If we think of the achievement scheme as a true national scheme then we must consider how we can accommodate candidates, not how we can stop them from participating.

The answer, of course, is that you, as an Examiner, must make on-the-spot decisions about what you will allow during the test and, in such cases, you are within your authority to take such decisions. The guidelines set out below may help but at all times the two items at the end of this section must take precedence. They are not negotiable and mean that, whoever the candidate is, they have to convince you that they know what they are doing or what is happening for the full duration of the test.

For instance, a disabled flyer may have difficulty handling the model and may not be able to carry it out to the strip, release it for launch or retrieve it after the flight. The sensible use of a helper is certainly allowable in such cases but it is essential that they only do what the candidate asks them to do. Pre-flight checks and engine starting may be another problem area that can be overcome by a helper but you should expect the candidate to do as much of the work as possible themselves and they should be able to talk you through anything that the helper does for them. Be sure to discuss all this with the candidate before starting the test.

All of these comments can apply to younger flyers too but there is an added complication with engine starting. Many parents are very unhappy about letting their children near a running engine and will not allow them to start their own engines. This is a perfectly valid view and, again, is a case where a helper can be used. If this situation does occur with the younger candidates, however, you should insist that they do all the pre-flight and preparation work themselves, up to applying the starter to the engine. If they cannot do this then they should not pass.

After engine start, the helper can adjust engine controls and carry the model but only on the instructions of the candidate.

In all cases:

- (1) If, at any time, the helper takes over the decision making process from the candidate then the candidate must fail.**
- (2) You can make no allowances whatsoever for anyone during the flying of the test. The candidate can either perform the flight manoeuvres as specified or they can't. If they can't then they must not be passed.**

Make sure in your briefing that both the candidate and the helper are fully aware of both of these points.

The 'BPC' and A Test

(A) Carry out pre-flight checks as required by the BMFA safety codes.

The pre-flight checks are laid out clearly in the BMFA Members' Handbook. The candidate should also go through the pre-flying session checks, also laid out in the Handbook. Ask the candidate to go through their checks as if the test was their first flight of the day. Particular attention should be given to airframe, control linkages and rotors.

Points to look for are that the candidate has a steady and regular ground routine, especially when starting and tuning the engine. Nerves should not play a part in the pits, and you should satisfy yourself that the candidate is in full control of what they are doing whilst preparing the helicopter for flight.

A tidy flight box and a neat ground layout makes a good impression but bear in mind that that 'A' certificate candidates may not have been flying for too long and you should make allowances.

A poor performance in this area is not direct grounds for failing the candidate but can certainly be part of a cumulative fail if other aspects of the performance are below the standard you expect.

Pay particular attention to the way the candidate uses the local frequency control system and make sure that they fully understand it and use the correct sequence appropriate to their model. For 35 MHz, this is usually 'get the peg, Tx on, Rx on'. For 2.4 GHz, the candidate should be aware of any local transmitter usage limitations and if a flight peg is required, it must be obtained before the usual Tx on, Rx on sequence. Some radio equipment and, occasionally, a specific model requirement requires that the Rx be switched on first and, if this is the case, the candidate should explain this clearly to you.

With electric powered models, take note that the candidate is aware that the model is 'live' as soon as the flight battery is plugged in and that they take appropriate safety precautions. If a separate receiver battery is fitted, the candidate should have the opportunity to check the operation of the radio equipment before the flight battery is plugged in.

Watch carefully and take note that the transmitter controls, trims and switches are checked by the pilot.

All candidates are required to be aware of the local the frequency control system and anyone who is required to use it but switches their radio on before doing so should be failed on the spot.

With i/c powered models, it is important that the candidate is seen to hold the rotor head securely during the starting procedure and until the model is past the flight line.

Electric powered models must be carried out from the pits area to a safe point before the flight battery is connected and they **MUST** be considered live as soon as the flight battery is plugged in. Great care should be taken at this point and any help available to the candidate should be used in the interests of safety.

If there is no one else available then there is nothing to stop you aiding the candidate by, for instance, carrying the model to the test area etc. but any such actions must be performed by you directly on the instructions of the candidate. You must not prompt them or carry out any actions of your own accord.

It is important that you talk these points over with the candidate in you pre-flight briefing.

(b), (c), (d), (e), (f) and (g) together form a horizontal 'T'.

During the course of manoeuvres (b), (c), (d), (e), (f) and (g) the model should not have deviated significantly from a straight line drawn between the end points Slight drifting may be

permissible in adverse wind conditions, but should be rapidly corrected and put back on the correct course. If the deviation is severe, or the model does not follow the line at all, the candidate should not pass. The hovering speed between the end points is at the discretion of the candidate but must be no faster than a slow walk.

Each stop should be a controlled hover, with any movement being quickly checked, without signs of large over-corrections. The pauses at each hovering point should be about five seconds, other than in (b).

The height of the helicopter should be consistent throughout these manoeuvres with no major deviations.

(b) Take off and hover tail in over the take-off point, with the helicopter skids at approximately 10 feet, for about twenty seconds and then land.

Take off should be smooth and the lift to 10 feet should be vertical, straight and controlled with the model a comfortable and safe distance in front of the pilot. Once at 10 feet the model should remain stationary, and the tail should not oscillate unduly. You should notify the candidate when the hover time of about twenty seconds has passed and ask him to commence with the next part of the manoeuvre. The descent and landing should be smooth and steady with little oscillation of the tail on touchdown caused by poor tail control.

(c) Take off and hover for about five seconds, then hover the helicopter slowly forwards for approximately five metres, stop, and hover for about five seconds.

After the take off and five seconds hover time and, on your command, the pilot now hovers the model forward, at a slow hovering pace, for a distance of about five metres then stopping and hovering for about five seconds. All the previous comments about line, height at 10 feet, speed and steadiness apply and the orientation of the model should still be facing in the same direction as this initial forward hover, as for all the rest of the first set of manoeuvres.

(d) Hover the helicopter slowly sideways for approximately five metres, stop, and hover for about five seconds.

The pilot may choose to perform the initial sideways hover in either direction (to his left or right) and, once you have been told the direction, the candidate should, without turning the model, commence a sideways hover at 10 feet for a distance of approximately five metres. Having travelled about five metres the pilot will stop the model and hold it in a steady hover at 10 feet and, with the tail pointing in the same direction as it was when it took off, for about five seconds

(e) Hover the helicopter slowly sideways in the opposite direction for approximately ten metres (five metres past its original position in front of the pilot), stop, and hover for about five seconds.

At the end of the hover time the pilot, without turning the model, will hover it sideways in the opposite direction, passing in front of them and stopping 5 metres past the centre line. At this point the pilot will once again stop and hover the model with it still facing in the same direction as it was at take-off.

(f) Hover the helicopter slowly sideways in the first direction to bring it back to its original position in front of the pilot, stop, and hover for about five seconds.

The candidate should, without turning the model, commence a sideways hover at 10 feet for a distance of approximately five metres back to the centre marker. Having travelled to the centre marker the pilot will stop the model and hold it in a steady hover for about five seconds at 10 feet and, with the tail pointing in the same direction as it was when it took off.

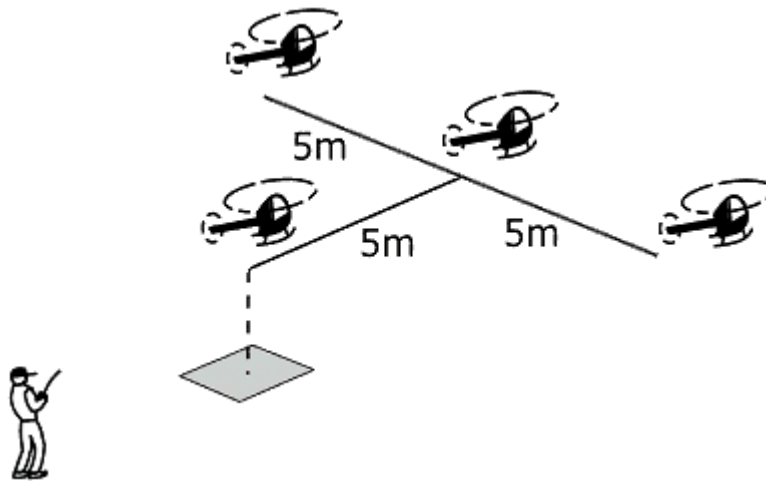

(g) Fly slowly backwards, bringing the helicopter back to its original position over the take off point, stop, hover for about five seconds and land.

After hovering for about five seconds, the model is hovered backwards (without turning it) to the start position, stopped and hovered for about five seconds above the TOLP with skids at 10 feet. After the hover time has been completed the model should descend and land close to the original take off point. During this last section, you will be observing the same criteria as previously and the model should have performed as before in relation to the course and at a similar speed. The descent and landing should be smooth and steady with little oscillation of the tail on touchdown caused by poor tail control.

(h) Take off and fly slowly forward for approximately 5 metres, stop and hover for about five seconds. Turn 90 degrees either left or right and fly forward to perform two 'lazy eights', each at least 30 metres in length. Each time the helicopter passes in front of the pilot it must be sideways on to the pilot and throughout the manoeuvre the model must be flying forward, not sideways.

The pilot should make a quick visual check that the area he intends to overfly is clear and that no other models are flying in the near vicinity; you should be watching for definite head movements as they scan the area.

The pilot should fly this manoeuvre at a safe height above 10 feet, but should not fly at such a height that the model cannot be clearly seen by both the pilot and yourself. Between 10 feet and five metres is the correct height band for this part of the test and the model **must** hover through the lazy eights, not fly through them. The pilot must be clear about the height at which they wish to fly before they take-off and you should discuss this with them in the pre-flight briefing.

Having ensured that it is safe to start the manoeuvre, the pilot then takes the model off, rises smoothly to the flight level previously selected and hovers forwards for approximately 5 metres, stopping over the centre marker and hovering for about five seconds.

The pilot then turns the model 90°, either left or right and, at the same time, slowly moves off forward at about a **walking pace** (but still in the hover). It is not required that the 90° turn is completed before the model accelerates; the turn and acceleration may be one smooth manoeuvre although the pilot may treat them as separate manoeuvres if they wish.

The pilot moves away at his chosen height for a distance of about fifteen metres where they begin a turn the model smoothly through 180°, flying forward in the hover all the time, and bringing the model back across in front of them. Without hesitation the model continues at the

same speed in the new direction until it has flown past the pilot for a further fifteen metres to his opposite side. At this point he smoothly executes another 180° turn, causing the model to be now moving in the same direction as the first leg, again hovering across in front of the pilot.

The model does not stop at this point but it then repeats the events of the first lazy eight until two full eights have almost been completed and the model is near or over the centre ground marker.

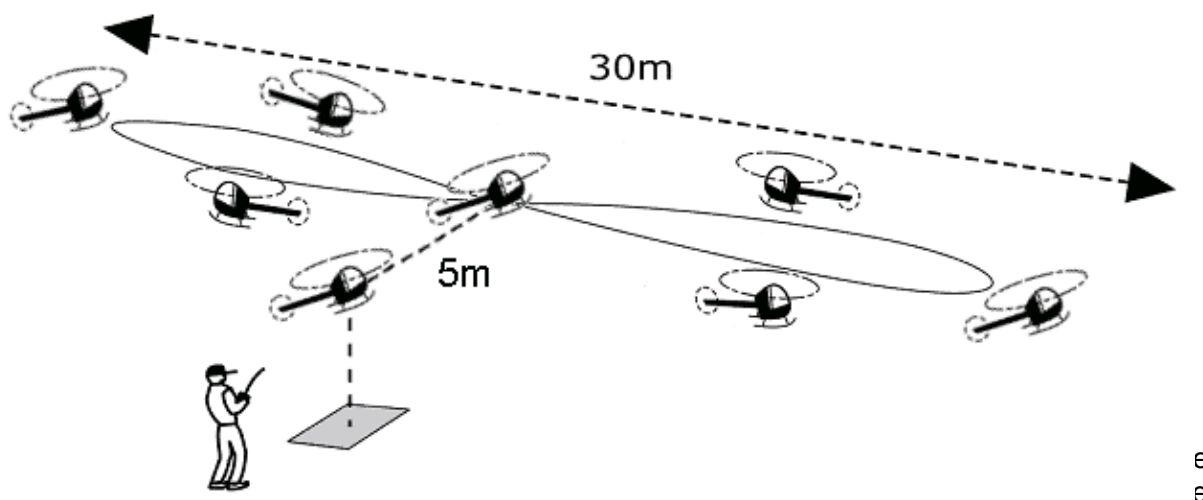

between the turns with only sufficient drift on the model to prevent the it from moving either further away or, more dangerously, closer to himself during each leg of the manoeuvre. The **overall** length of each eight should be at least thirty metres and the model must be sideways on to the pilot each time it passes across their front. Some allowance can be made for a strong or gusty wind but the basic points of the manoeuvre must still be demonstrated.

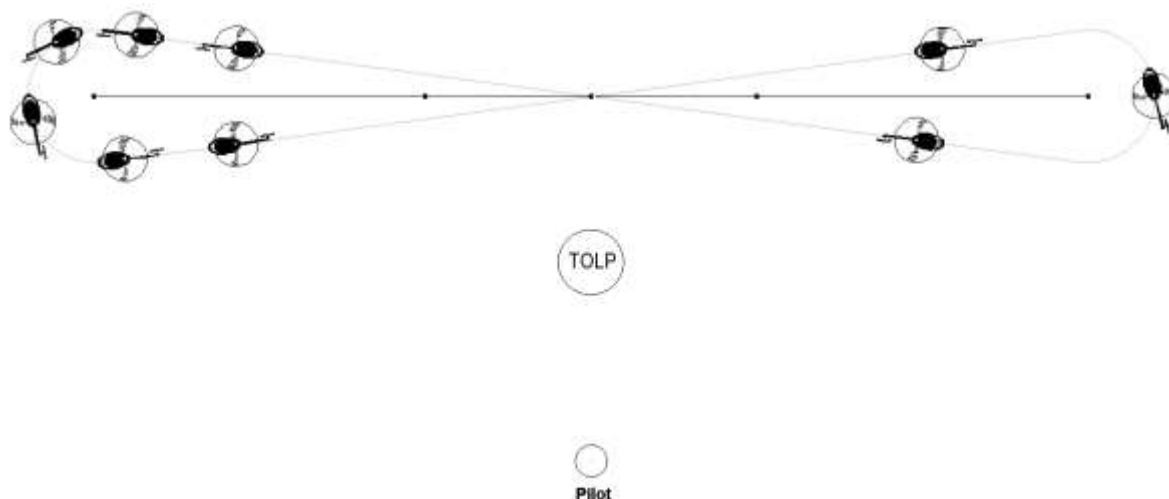

At no time during the manoeuvre should the model be flying sideways. Throughout all the turns and straight flight, it must be flying forward in the hover and not 'crabbing' sideways.

The turns should be made by use of cyclic and rudder co-ordinated correctly, and must **not** be half pirouettes at the end of each leg. The flight pattern should be as the diagram in the BMFA Members' Handbook and not deviate significantly from it. The pilot should be equally competent to the left and to the right when flying this manoeuvre. If any significant difference

in their flying skills shows up here then you should seriously consider whether they show the degree of competence necessary. It should be borne in mind that the manoeuvres in the test have been made reasonably simple, so that a fairly high degree of control can be demanded.

(i) At the conclusion of the two 'lazy eights', bring the helicopter to a halt sideways-on over the centre marker. Turn the model tail in to the pilot and hover for about five seconds. From this point fly the model to a landing on the original take off point.

At this point the model should be approaching the area of the centre marker, still at the chosen manoeuvre height, and the pilot should aim to smoothly decelerate the model to a stop in front of and sideways on to himself. The model is then turned to the heading it had before the lazy eights were started and hovered for about five seconds. At this point it should be over the centre marker, about five metres in front of the TOLP and hovering at the standard height.

The model is now flown to a landing at the original take-off point. The path taken is entirely at the discretion of the pilot and you should take the opportunity to watch carefully for a smooth well-thought-out and safe manoeuvre.

After landing, the candidate should shut down the engine and allow the rotor blades to stop turning before collecting the model to return to the pits.

Remember that electric models must be assumed to be 'live' until the flight battery has been disconnected and the handling of the aircraft by the candidate must reflect this during retrieval and in the pits area.

(i) Complete post flight checks as required by the BMFA Safety Codes.

These are clearly set out in the BMFA Members' Handbook, but you should pay particular attention to the correct Rx off, Tx off sequence and watch carefully to see that the frequency control system in use is cleared correctly.

The 'B' Test

The Test

(a) Carry out pre-flight checks as required by the BMFA Safety Codes.

The pre-flight checks are laid out clearly in the BMFA Members' Handbook. The candidate should also go through the pre-flying session checks, also laid out in the handbook. Ask the candidate to go through their checks as if the test was their first flight of the day.

Points to look for are that the candidate has a steady and regular ground routine, especially when starting and tuning the engine. Nerves should not play a part in the pits, and you should satisfy yourself that the candidate is in full control of what they are doing whilst preparing the helicopter for flight.

A tidy flight box and a neat ground layout makes a good impression and is to be expected from 'B' certificate candidates

A poor performance in this area is not direct grounds for failing the candidate but it is inevitable that you will be making mental notes of all aspects of the candidates performance and this is one that may have an effect on a real 'borderline' case.

Pay particular attention to the way the candidate uses the local frequency control system and make sure that they fully understand it and use the correct sequence appropriate to their model. For 35 MHz, this is usually 'get the peg, Tx on, Rx on'. For 2.4 GHz, the candidate should be aware of any local transmitter usage limitations and if a flight peg is required, it must be obtained before the usual Tx on, Rx on sequence. Some radio equipment and, occasionally, a specific model requirement requires that the Rx be switched on first and, if this is the case, the candidate should explain this clearly to you.

With electric powered models, take note that the candidate is aware that the model is 'live' as soon as the flight battery is plugged in and that they take appropriate safety precautions. If a separate receiver battery is fitted, the candidate should have the opportunity to check the operation of the radio equipment before the flight battery is plugged in.

Watch carefully and take note that the transmitter controls, trims and switches are checked by the pilot.

All candidates are required to be aware of the local the frequency control system and anyone who is required to use it but switches their radio on before doing so should be failed on the spot.

With i/c powered models, it is important that the candidate is seen to hold the rotor head securely during the starting procedure, and until the model is past the flight line.

Electric powered models must be carried out from the pits area to a safe point before the flight battery is connected and they MUST be considered live as soon as the flight battery is plugged in. Great care should be taken at this point and any help available to the candidate should be used in the interests of safety.

If there is no one else available then there is nothing to stop you aiding the candidate by, for instance, carrying the model to the test pad, etc., but any such actions must only be performed by you directly on the instructions of the candidate, you must not prompt them or carry out any actions of your own accord.

It is important that you talk these points over with the candidate in your pre-flight briefing.

(b) Perform one hovering bow tie

All sections of the manoeuvre are numbered and referenced to the manoeuvre drawing. The manoeuvre as described is flown anti-clockwise. However the direction of the flight may be either clockwise or anti-clockwise, at the discretion of the Examiner.

At all times in the manoeuvre, the model must be facing forward.

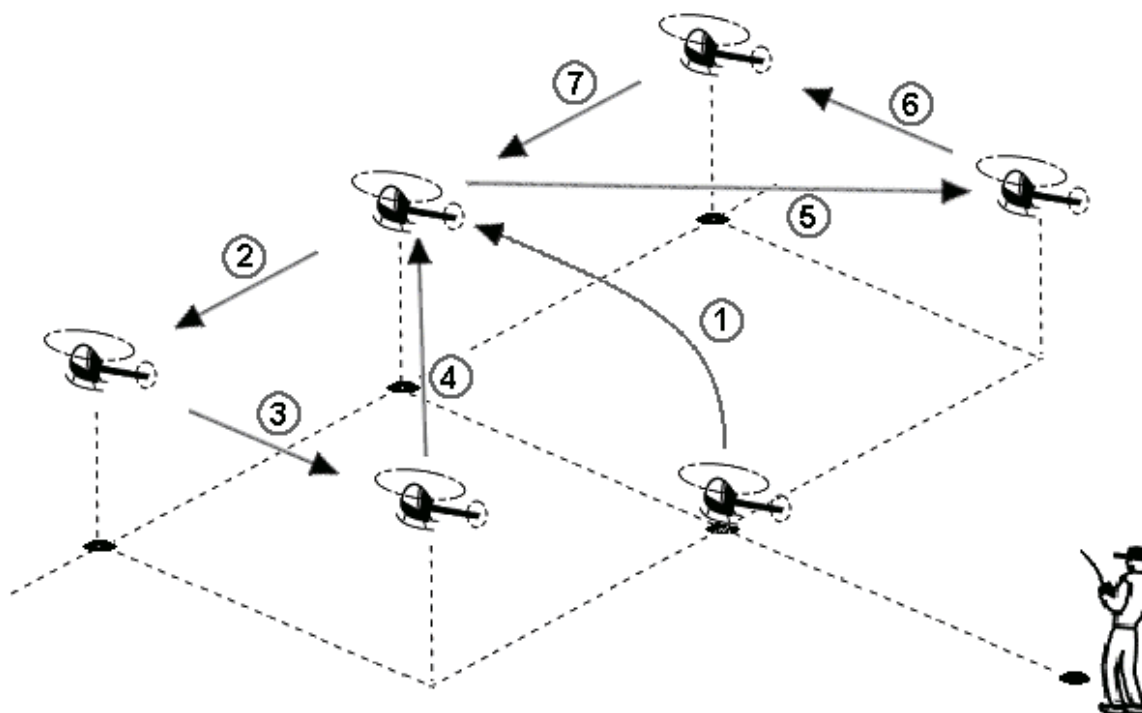

- (1) The model starts on the TOLP, takes off and flies to a position over the centre marker where it is hovered for about 5 seconds.
- (2) The model then hovers sideways to the left for about 5 metres to a position over the left inner marker where it is held and hovered for about 5 seconds.
- (3) The model then hovers backwards for about 5 metres to a position immediately behind the left inner marker and level with the TOLP where it is held and hovered for about 5 seconds.
- (4) The model then hovers diagonally forward and to the right to a position over the centre marker where it is held and hovered for about 5 seconds.
- (5) The model then hovers diagonally backward and to the right to a position immediately behind the right inner marker and level with the TOLP where it is held and hovered for about 5 seconds.
- (6) The model then hovers forwards for about 5 metres to a position over the right inner marker where it is held and hovered for about 5 seconds.
- (7) The model then hovers sideways to the left for about 5 metres to a position over the centre marker where it is held and hovered for about 5 seconds.

This completes the manoeuvre.

Hover height must be consistent throughout the manoeuvre and there should be minimum wandering away from the straight lines between the designated hovering points as the manoeuvre is flown.

(c) Perform one 4-point pirouette

From the previous manoeuvre, the manoeuvre is begun with the helicopter hovering over the centre marker, tail-in to the pilot and it is held in that position for about 5 seconds. The model is then rotated 90 degrees and held in the hover, sideways on to the pilot for about 5 seconds.

The model is then rotated a further 90 degrees in the same direction to be nose in to the pilot and hovered in that position for about 5 seconds.

The model is then rotated a further 90 degrees in the same direction to the sideways on position to the pilot and hovered in that position for about 5 seconds

The model is then rotated a further 90 degrees in the same direction to the tail-in position to the pilot and hovered in that position for about 5 seconds.

The model is then hovered backwards for approximately 5 metres and landed on the TOLP.

This completes the manoeuvre.

The helicopter must rotate either clockwise or anti-clockwise for the entire manoeuvre. The Examiner will state which direction he wishes to see. The clear inference is that the candidate must be competent to perform the rotations in both directions prior to the test.

Hover height must be consistent throughout the manoeuvre with minimum wandering away from the Centre marker. The landing must be within the 2 metre diameter circle centred on the TOLP.

(d) Perform one 'Top Hat'

The pilot should now take off and hover the model to a position either hovering over the appropriate outer marker or approaching it at hovering pace along the line of the cross markers at 10 feet height. The model now moves forward at the normal hovering pace for ten metres, stops and hovers for about five seconds then climbs vertically for four metres before hovering again for about five seconds. The pilot will now hover the model forward for ten metres so that the model passes the pilot sideways on to them. The model again hovers for about five seconds and the pilot now causes the model to descend four metres until the skids are once again at 10 feet where it again hovers for about five seconds. The model now moves forward for another ten metres and passes over the opposite end outer marker which concludes the manoeuvre.

The model, still with skids at 10 feet, must then be hovered back to the take off/landing point and landed smoothly and steadily.

The speed during the top hat should approximate to a normal walking pace, and the heading is constant throughout. The entry and exit to the manoeuvre is a test of the pilots ability to correctly position the model. The model should not drift away from or toward the pilot significantly and the model should be under accurate control for the whole manoeuvre.

The manoeuvre may be flown either from left to right or from right to left and the direction is decided by the Examiner.

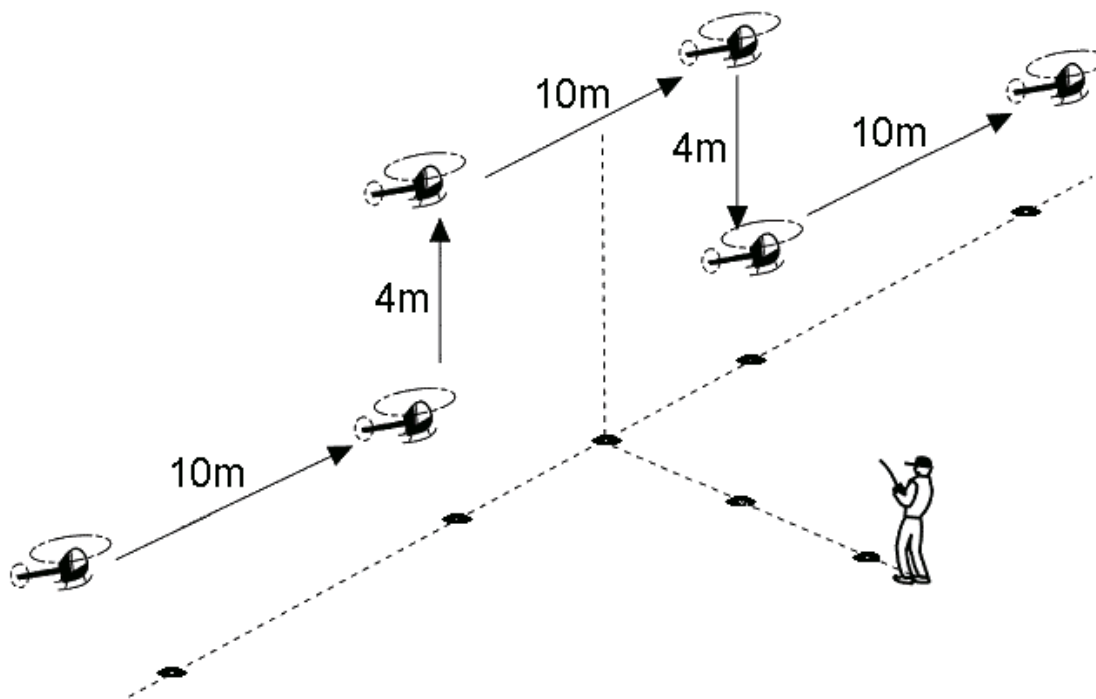

(e) Take off and climb to a safe altitude.

The pilot must ensure that the route of his proposed flight path is clear before taking-off; watch for head movement as they scan the area. On taking-off, the helicopter will lift to a brief hover at about half a metre high. After again checking for obstacles and obstructions the pilot then climbs out at an angle greater than 45° to his selected safe height. When reaching this height the model can be transitioned into forward flight and the pilot can now position it for either a left or right hand circuit as he pleases.

During the climb out you will be looking for a positive approach to the manoeuvre, a constant angle and velocity. the pilot will also be looking for other traffic along the intended route.

(f) Fly a left hand rectangular circuit.

(g) Fly a right hand rectangular circuit.

The pilot can elect to fly these manoeuvres in either order. The circuits should be rectangular as shown in the manoeuvre diagrams. the longest legs of the circuit must extend over at least fifty metres. It is important that the initial turn on each circuit is made away from the flight line and the model must never pass behind the pilot.

On the run in to the first circuit and on completion of it, the model will be flying past the front of the pilot, and, for safety reasons, twenty or thirty metres out from the take off pad. Tell the candidate prior to the flight the line you wish them to follow.

You must ensure that the candidate is clear on this, the line will be set by the model flying in front of them on a heading which will be agreed before the flight (and this will not always be into wind), and passing over a set point. The first pass in front of the pilot is extremely important as it sets the standard height and line for the rest of the 'flying' manoeuvres.

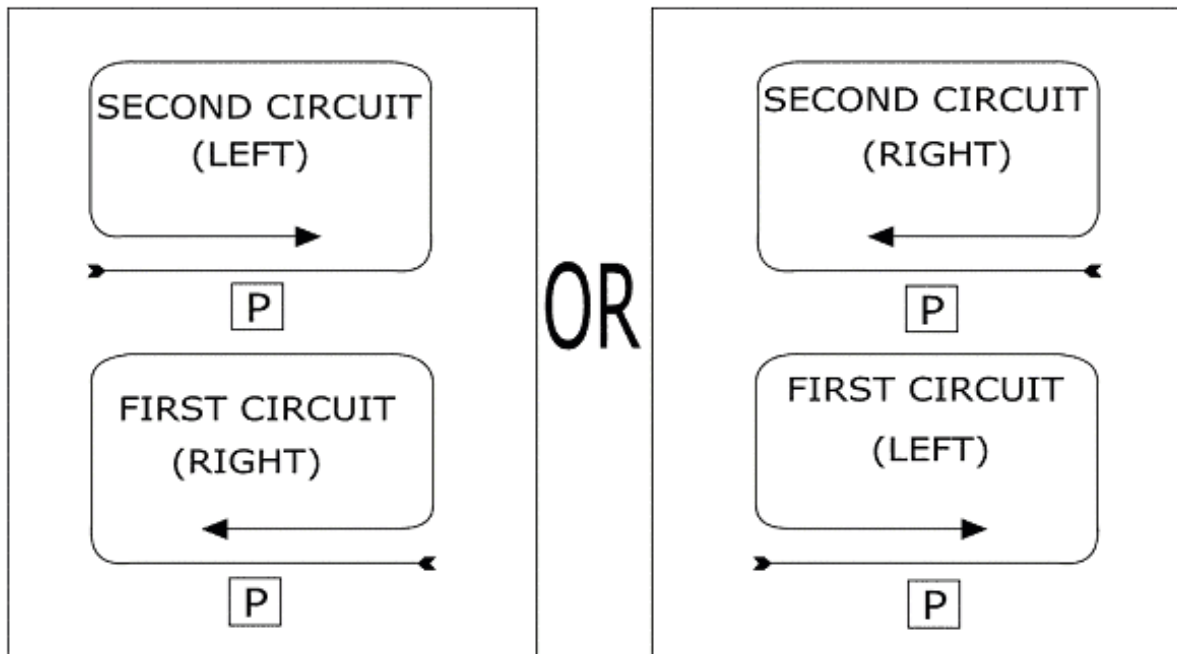

(h) Fly a Figure of Eight at circuit height with crossover in front of the pilot

This should be flown as a banked circuit manoeuvre (not from the hover) and as shown in the diagram. The crossover point must always be in front of the pilot and, after a run in at standard height and line, the model MUST be turned through ninety degrees in the first turn so that it is flying exactly away from the pilot.

The first circle must also end with the model flying exactly away from the pilot, through the crossover point before it is turned into the second circle. Both circles should be of the same diameter as seen from the ground.

The main problems with this manoeuvre nearly always happen on the circle that is upwind of the pilot and if they do not adjust the angle of bank/turn rate to compensate they will either miss the crossover point by being a good way downwind, fly too near the pilots line, fly circles that are distorted or panic as the model accelerates towards them as it begins to come downwind and pull far too much bank (vertical!) to get the crossover point correct. This is not a sign that they have thought about the manoeuvre or practised it.

The second circle (3/4 circle actually) is rarely a problem. The manoeuvre finishes with the model flying at standard height and line across the front of the pilot, not with another turn away.

The initial run-in to the manoeuvre may be either from left to right or from right to left and the direction is decided by the Examiner.

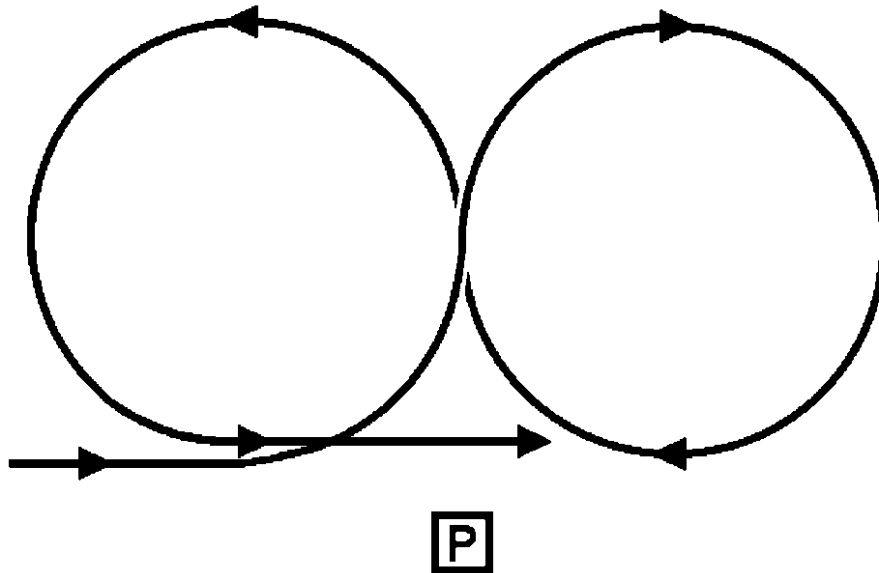

(i) Perform one twenty second nose-in hover.

The model must now transition from forward flight to the hover in a safe and steady manner and position for the nose-in hover.

The pilot should position the model over the centre marker, hovering at a height of approximately three metres. After a brief hover, the model is turned so that the nose is towards the pilot and held steadily in the nose-in hover for at least 20 seconds, then turned back, climbed away and transitioned to forward flight.

When the model is in the nose in position the tail boom should not be visible to the pilot. If the model is not completely nose in you should ask the pilot to correct it's position before starting the twenty second count. The helicopter should not drift significantly in any direction and height control should be good.

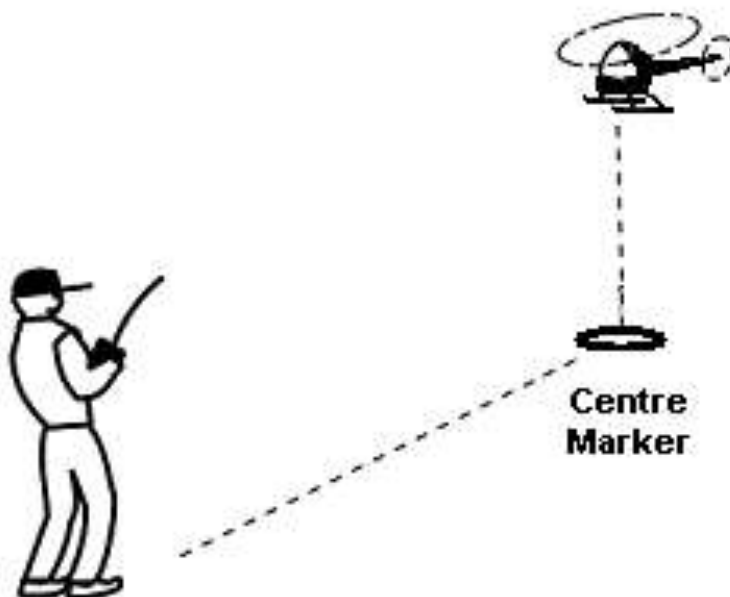

(j) Perform one double stall turn. Note that the stall turns must be performed with opposite rotation i.e. first one to the left, second one to the right or vice versa.

This manoeuvre is flown as one continuous manoeuvre. During the first element, the model should be flown in, on standard height and line, across in front of pilot to a point between thirty and fifty metres past the pilot. The model should then be pulled into a near vertical climb. At the top of the climb the model must stop (still pointing upwards) before being turned 180° about its vertical axis (a half pirouette). The model should descend approximately down the same path in a diving attitude and should pull out of the dive and exit the manoeuvre at about the same height as it started but on a reciprocal heading.

The second element is flown after the model has flown back down its original entry path and is performed approximately as far to the side of the pilot as the first element was to the other side. The description of the second element is exactly as for the first except that the pull-out and exit from the manoeuvre takes the model back along its original entry path to the manoeuvre.

Both of the stall turns should be away from the flight line. That is, if the initial entry to the manoeuvre is from the left to the right of the pilot, the first stall turn will be to the left and the second stall turn will be to the right (fly it with your hands and all will become clear)

You should look for accurate positioning of the model between the stall turns, that is at a constant height and along the same line. The model should not be allowed to skew off its intended route, and should be corrected if it does. Clearly, wrong control inputs in this instance will indicate a lack of competence at the required level

The initial run-in to the manoeuvre may be flown either from left to right or from right to left and the direction is decided by the Examiner.

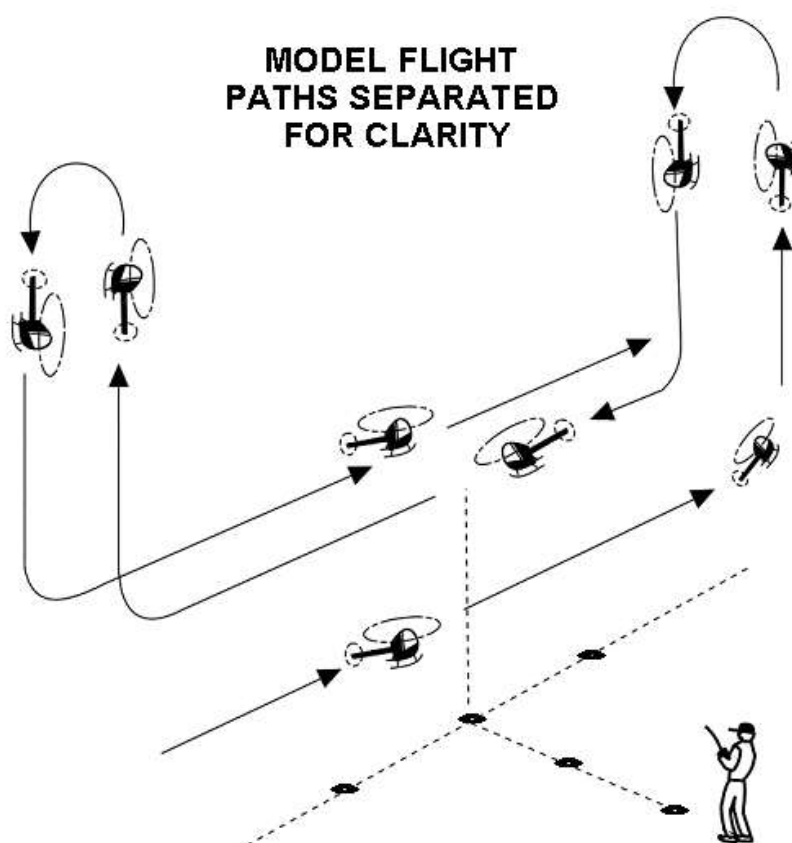

(k) Perform an approach at 45° to the vertical, landing within a pre-determined two metre square.

It is difficult to judge the angle of descent unless the model is almost sideways on to the pilot. For this reason the pilot should consider the planned approach path carefully and agree it with the Examiner during the pre-flight briefing. The direction of approach is the pilot's decision and everyone concerned with the test should be very clear exactly how the pilot will be attempting to fly the manoeuvre.

It is not a requirement that this manoeuvre should be entered from full forward flight so the pilot may set up the model in a steady hover or be moving forward in steady hovering flight at a minimum height of fifteen metres and at an appropriate distance away from the TOLP. The model should then sink at a constant rate with constant forward movement at an angle near to 45°, heading down towards the TOLP. Finishing this descent exactly over the TOLP is not required but the model should be no more than a metre or so out. The candidate is allowed a short hover at a height of around half a metre to make minor corrections before settling the model on the ground. **The landing should be made with the model on the same heading as on the 45° descent.**

After landing, the candidate should shut down the engine and allow the rotor blades to stop turning before collecting the model to return to the pits.

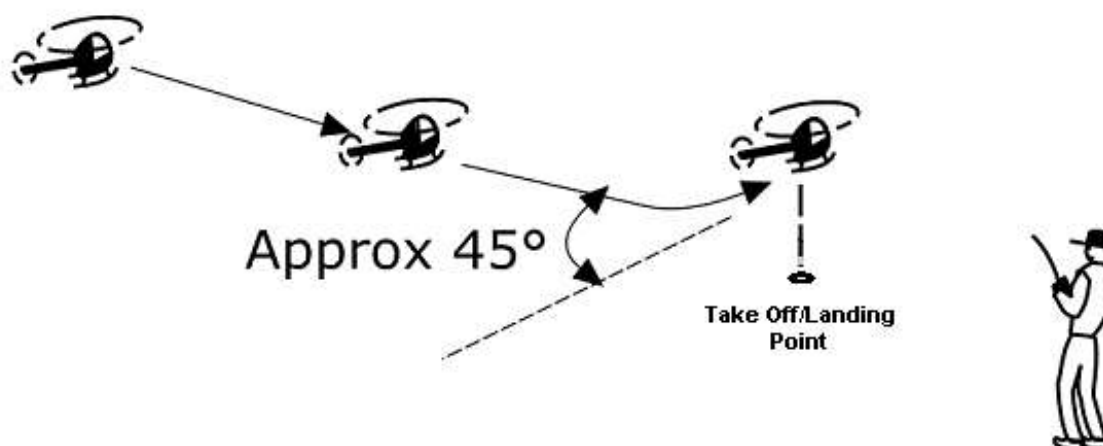

(l) Complete post flight checks as required by the BMFA Safety Codes.

These are clearly set out in the BMFA Members' Handbook, but you should pay particular attention to the correct Rx off, Tx off sequence and ensure that the frequency control system in use is cleared correctly.

All manoeuvres must be carried out in airspace and orientations pre-determined by the Examiner and Candidate prior to the commencement of the test flight. The test must be completed in one flight.

The test must be taken outdoors.

Exceptionally, at a pre-determined point in the flight an intermediate landing may be permitted for the sole purpose of either refuelling or the fitting of a freshly charged flight battery. This landing may only be made with the prior consent of the Examiners. The pre-determined point may be either after a specific manoeuvre or at a specific time of flight, whichever is requested by the candidate and agreed by the Examiners. Two attempts per examination will be allowed in any one day.

The use of helicopters with coaxial contra-rotating main rotors is not allowed.

Full pre and post flight checks are not normally required during an intermediate landing and takeoff unless the model suffered a hard landing. However, the candidate should give the model at least a quick visual examination whilst on the ground.

The Questions

Having successfully completed the safety and flying elements of the test, the candidate must then answer correctly five mandatory questions based on legal compliance, as well as a **minimum** of five further supplementary questions on safety matters, based on the BMFA Safety Codes for General Flying and local flying rules etc. for the for 'BPC' and 'A' certificate and a minimum of eight further questions on safety matters, based on the BMFA Safety Codes for General Flying and local flying rules and the 'Safety Code for Model Flying Displays' for the 'B' certificate.

Remember that on **no account** can a good performance on the questions make up for a flying test that you considered a failure. If you have failed the candidate's flying you should not even start to ask the questions. On the other hand the achievement scheme is a test of both flying ability and knowledge. It doesn't matter how well the candidate can fly, if they cannot answer the questions they should not pass.

Mandatory Questions

From April 2016 it is a requirement of all tests that candidates must answer correctly 5 questions taken from the list of mandatory questions based on legal aspects of model aircraft flying. (See Appendix 5) The examiner should only ask 5 questions and if the candidate does not know the answer to any question the test must be considered as a fail.

The examiner must indicate on the test form which questions have been asked.

It is expected that examiners will select questions that are appropriate to the test being taken, however candidates should familiarise themselves with all of the questions on the list. Candidates are not expected to be "word perfect" with their answers but they should be able to demonstrate that they are fully aware of the legal controls for model aircraft flying. For example if a candidate gives the answer to Question 4 (What does article 138 of the ANO state?) when asked Question 3 (What does article 137 of the ANO state?) it is likely they are aware of both answers and the examiner should point out they have answered the wrong question and ask for the correct answer.

Supplementary Questions

How many supplementary questions you should actually ask will depend on the circumstances at the time. For instance, if the candidate has done a good flying test and answers the first five questions (eight for B certificate) with confidence then you need go no further. An acceptable test but with some rough edges can be offset to an extent by the candidate performing well in the first five questions.

A candidate who has done a test which you found only just acceptable and who hesitates on the questions should be asked a few more than five/eight and if you are not satisfied that they have actually read the safety codes, you should not hesitate to fail them.

As an examiner, however, you should prepare yourself thoroughly for any testing that you do and you may wish to sort out your own personal and private list of sensible questions. Don't forget that you can use any local rules which you know and which the candidate should be aware of.

Remember that the majority of questions you ask are to be BASED on the BMFA Safety Codes; you are not expected to ask them 'parrot fashion' and the candidate is not expected to answer that way either.

This opens up the possibility of asking a candidate if they can think of reasons behind specific rules. For instance, why is the club frequency control system operated as it is and what might go wrong? There is always the possibility that the examiner may use the supplementary questions to further explore the candidates understanding of the mandatory questions.

Administration

There are specific forms for Examiners to use during the helicopter tests, and if you do not have one then a call to the BMFA Leicester office will have some in the post to you by return.

Examiners must indicate in the area provided which 5 of the mandatory legal questions have been asked.

Completed forms should be sent to the Leicester office within seven days of the test and, whilst they must be filled in by the Examiner, they may be sent in to the office by either the Examiner or the Candidate. You should take great care that all the details are filled in correctly, especially the successful candidates **NAME** and their **BMFA number** (this can save a great deal of confusion). If the candidate is not a BMFA member then it is especially important that you get their name and address correct and in full.

This is very important as what is seen on the pass form is what will appear on the final certificate. It is embarrassing for you to have to send one back to be re-done and it gives the candidate a definite impression of sloppy work by someone.

Please note that the A4 Certificate(s) and updated membership card are not routinely sent directly to the individual tested. However, the Leicester office will send the documents directly to the individual, upon direct and specific request from the Examiner concerned.

Appendix 1

Examiners and Candidates 'BPC' and 'A' Test Check List

The following is a short checklist of matters to discuss with the candidate taken from this document. This checklist can be used to ensure that all points raised above have been discussed with the pilot prior to any flights:

- 1 Has the candidate read: -
The BMFA handbook
Local site rules (if applicable)
'Safety Code for General Flying'
and 'Operational Guide, All Models and Radio Control'.

- 2 Discuss whether the model is suitable in "these conditions"

- 3 Any "no fly zones" need to be identified

- 4 Remind candidate to talk you through anything that the helper may do for them as the test progresses

- 5 Agree any manoeuvre requirements that need to be pre-determined by the Examiner and Candidate prior to the commencement of the test flights

- 6 Clearly identify the take off / landing point and agree with the candidate the required hovering times that he will be flying and you will be looking for.

Appendix 2

Examiners and Candidates 'B' Test Check List

The following is a short checklist of matters to discuss with the candidate taken from this document. This checklist can be used to ensure that all points raised above have been discussed with the pilot prior to any flights:

- | | | |
|---|---|--------------------------|
| 1 | Has the candidate read: -
The BMFA handbook
Local site rules (if applicable)
'Safety Code for General Flying'
'Operational Guide, All Models and Radio Control'
Code of Practice for Model Flying Displays | <input type="checkbox"/> |
| 2 | Discuss whether the model is suitable in "these conditions" | <input type="checkbox"/> |
| 3 | Any "no fly zones" need to be identified | <input type="checkbox"/> |
| 4 | Remind candidate to talk you through anything that the helper does for them as the test progresses | <input type="checkbox"/> |
| 5 | Agree any Airspace requirements that need to be pre-determined by the Examiner and Candidate prior to the commencement of the test flights | <input type="checkbox"/> |
| 6 | Discuss the various manoeuvres and any options that may be available so that there can be no misunderstanding during the test | <input type="checkbox"/> |
| 7 | In particular, does the candidate understand how you expect to see the model positioned with regard to the wind throughout the test. | <input type="checkbox"/> |
| 8 | Clearly identify the landing area and agree with the candidate the required landing pattern that he will be flying and you will be looking for. | <input type="checkbox"/> |

Appendix 3

'BPC' & 'A' CERTIFICATE (HELICOPTER)
Examiners Test Flight Check List

Candidates Name	BMFA Number	Date	Examiner

FLIGHT TASK		COMMENTS
(a)	Carry out pre-flight checks as required by the BMFA Safety Codes.	
(b)	Take off and hover tail in over the take off point, with the helicopter at 10 feet, for about twenty seconds and then land.	
(c)	Take off and hover for about five seconds then hover the helicopter slowly forwards for approximately five meters, stop, and hover for about five seconds.	
(d)	Hover the helicopter slowly sideways for approximately five meters, stop, and hover for about five seconds	
(e)	Hover the helicopter slowly sideways in the opposite direction for approximately ten meters (five meters past its original position in front of the pilot), stop, and hover for about five seconds.	
(f)	Hover the helicopter slowly sideways in the first direction to bring it back to its original position in front of the pilot, stop, and hover for about five seconds.	
(g)	Fly slowly backwards, bringing the helicopter back to its original position over the take off point, stop, hover for about five seconds and land	
(h)	Take off and hover forward for about five meters, stopping over the centre ground marker and hover for about five seconds. Turn 90 degrees either left or right and fly forward to perform two 'lazy eights', each at least 30 meters in length. Each time the helicopter passes in front of the pilot it must be sideways on to the pilot and throughout the manoeuvre the model must be flying forward, not sideways.	
(i)	At the conclusion of the 'lazy eights', bring the helicopter to a halt above the centre ground marker, turn the model tail in to the pilot and hover for about five seconds. Then fly to the original take off point, and land.	
(j)	Complete post-flight checks as required by the BMFA Safety Codes.	
Answer five questions from the list of mandatory questions on legal aspects of model aircraft flying.		
Answer a minimum of five questions on safety matters from the BMFA Safety Codes and local flying rules.		

Appendix 4

'B' CERTIFICATE (HELICOPTER)

Examiners Test Flight Check List

Candidates Name	BMFA Number	Date	Examiners

FLIGHT TASK		COMMENTS
(a)	Carry out pre-flight checks as required by the BMFA Safety Codes	
(b)	Perform one hovering 'bow tie	
(c)	Perform one four-point pirouette	
(d)	Perform one 'Top Hat' then land	
(e)	Take off and climb to a safe altitude	
(f)	Fly a left rectangular hand circuit	
(g)	Fly a right rectangular hand circuit	
(h)	Perform one figure eight at circuit height	
(i)	Perform one twenty second nose-in hover	
(j)	Perform one double stall turn with opposite rotation	
(k)	Perform an approach at 45° to the vertical, landing within a predetermined two metre square	
(l)	Complete post-flight checks as required by the BMFA Safety Codes	
Answer five questions from the list of mandatory questions on legal aspects of model aircraft flying.		
Answer satisfactorily a minimum of eight questions on safety matters based on the BMFA Safety Codes for General Flying and Model Flying Displays and local flying rules.		

Appendix 5

Mandatory Question List

Q(1) Who Regulates all civil flying activities over the United Kingdom, including model aircraft ?

A The Civil Aviation Authority

Q(2) How are the rules and regulations for flying established in law by Parliament (statute) ?

A As a series of Articles contained within in the Air Navigation Order (ANO).

Q(3) What does Article 240 (previously 137) of the ANO state ?

A 'A person must not recklessly or negligently act in a manner likely to endanger an aircraft, or any person in an aircraft.'

Q(4) What does Article 241 (previously 138) of the ANO state ?

A 'A person must not recklessly or negligently cause or permit an aircraft to endanger any person or property.'

Q(5) Who is legally responsible to ensure that a model is flown safely ?

A The pilot in command

Q (6) Which Civil Aviation Publication (CAP) relates specifically to the use of model aircraft, and for which specific purposes only ?

A CAP 658, for sport and recreation purposes only

Q(7) According to CAP 658, which model aircraft are required to have an operating failsafe and what is the minimum setting ?

A

- 1) Any aircraft >7kg
- 2) Any Gas Turbine powered aircraft
- 3) Any powered model aircraft fitted with a receiver capable of operating in failsafe mode

As a minimum, reduce the engine(s) speed to idle on loss or corruption of signal.

Q(8) What does Article 94 (previously 166) of the ANO say about the responsibilities of the person in charge of a small unmanned aircraft ?

A The person in charge of a small unmanned aircraft may only fly the aircraft if reasonably satisfied that the flight can safely be made.

Q(9) What does Article 94 (previously 166) of the ANO say about visual contact with small unmanned aircraft ?

A The person in charge must maintain direct, unaided visual contact with the aircraft sufficient to monitor its flight path in relation to other aircraft, persons, vehicles, vessels and structures for the purpose of avoiding collisions.

Q(10) What does Article 94 (previously 166) of the ANO say about small unmanned aircraft above 7kg ?

A The person in charge of a small unmanned aircraft which has a mass of more than 7 kg must only fly the aircraft:

- Clear of controlled airspace unless with Air Traffic Control (ATC) permission.
- Clear of any Aerodrome Traffic Zone (ATZ) unless with ATC permission.
- At less than 400 ft above the point of launch except with permission as above.

Q(11) What does Article 94 (previously 166) of the ANO say about 'commercial operation' (previously referred to as aerial work) for small unmanned aircraft ?

A The person in charge of a small unmanned aircraft must not fly the aircraft for the purposes of aerial work except in accordance with a permission granted by the CAA.

Q(12) How is a flight for the purpose of 'commercial operation' (previously referred to as aerial work) defined ?

A Any flight for which 'valuable consideration' is given or promised in respect of the flight or the purpose of the flight. Essentially any gain you may make from the work undertaken.

Q(13) How is 'a small unmanned surveillance aircraft' defined ?

A An aircraft which is equipped to undertake any form of surveillance or data acquisition.(this includes all camera equipped aircraft)
NOTE: The provision of data solely for the use of monitoring the model is not considered to be applicable to the meaning of 'surveillance or data acquisition'.

Q(14) What are the separation requirements of Article 95 (previously 167) - for small unmanned surveillance aircraft - when operating over or within a congested area or organised open-air assembly of more than 1,000 persons ?

A The aircraft must not fly over or within 150 metres of a congested area or organised open-air assembly of more than 1,000 persons

Q(15) What are the separation requirements of Article 95 (previously 167) - for small unmanned surveillance aircraft - in respect of any vessel, vehicle or structure which is not under the control of the person in charge of the aircraft ?

A The aircraft must not fly within 50 metres of any vessel, vehicle or structure not under the control of the person in charge of the aircraft.

Q(16) Except during take-off and landing, what are the separation requirements of Article 95 (previously 167) - for small unmanned surveillance aircraft – excluding the person in charge of the aircraft or anyone under their control ?

A The aircraft must not fly within 50 metres of any person

Q(17) What must be obtained before any flight within controlled airspace or an ATZ of an aircraft over 7kg?

A Obtain permission from the appropriate air traffic control unit.

Q(18) CAA General Exemption E 4049 - permits FPV flight without a buddy box, but with a competent observer. (a) How must the competent observer monitor the flight and (b) What is the maximum mass of aircraft that may be flown under this exemption?

A

- (a) The competent observer must maintain direct unaided visual contact with the model at all times
- (b) The aircraft must be below 3.5kg including batteries and fuel

Q(19) Who has legal responsibility for the safety of an FPV flight a) conducted with a buddy box lead and b) conducted without a buddy box lead ?

A

- (a) The person in charge who must maintain direct unaided visual contact with the model at all times
- (b) The person piloting the aircraft (SUA)

Q(20) According to CAP 658 what are the 8 'Only fly if' checks for an FPV flight of an aircraft over 3.5kg ?

A

- The activity is solely for 'sport and recreation' purposes;
- Two pilots take part;
- A Buddy Box system is employed;
- The person in charge operates the master transmitter;
- The person in charge does not wear the headset or view a screen;
- The aircraft remains within the natural unaided visual range of the person in charge;
- Reliable operation of the Buddy Box is established; and
- A clear handover protocol is established.

BRITISH MODEL FLYING ASSOCIATION

SMAE Ltd

Chacksfield House, 31 St Andrews Road, Leicester, LE2 8RE

Telephone - 0116 2440028 Fax - 0116 2440645

E-Mail - admin@bmfa.org Website - <http://www.bmfa.org>